

MPE[®]

MPE **MANH PHUONG ELECTRIC**

Email: info@mpe.com.vn
www.mpe.com.vn

■ **MPE USA:**

1 Coleman St., The Adelphi Tower, Singapore
Tel: (+65) 6333 4753 - Fax: (+65) 6333 4754

■ **Head Office:**

272A Nguyen Trai St, Ward 8, Dist. 5, HCMC, Vietnam
Tel: (84-8) 3924 1853 - Fax: (84-8) 3924 1602

■ **Ho Chi Minh Branch:**

L37 Mieu Noi, Ward 3, Binh Thanh Dist, HCMC, Vietnam
Tel: (84-8) 517 2253 - Fax: (84-8) 3924 1602

■ **Ha Noi Branch:**

16A3 Floor, 25 Quang Trung St., Nguyen Du Ward, Hai Ba Trung Dist, Ha Noi, Vietnam
Tel: (84-4) 3944 9845 - Fax: (84-4) 3944 9845

■ **Da Nang Branch:**

114 Nguyen Dinh Tuu St., Da Nang City, Vietnam
Tel: (84-511) 372 6286 - Fax: (84-511) 372 6287

■ **Can Tho Branch:**

239, 30/4 St., Hung Loi Ward, Ninh Kieu Dist., Can Tho City, Vietnam
Tel: (+84-710) 625 0079 - Fax: (+84-710) 625 0939

■ **Factory:**

Lot II - 6, Industry Group II, 11st Street, Tan Binh Industry Park, HCMC, Vietnam
Tel: (08) 3816 5296 - Fax: (08) 3816 5299



Electrical Equipment

CATALOGUE 2015 - 2016

GERMANY TECHNOLOGY



Factory 1 (Tan Binh Industry Park)



Factory 2 (Tan Binh Industry Park)



INTRODUCTORY



The first word on behalf of power companies Manh Phuong, please send gratitude to our customers for favors and support our company during the past years.

Founded in 1999, so far with the branch network and representative offices spread across 3 North, Central, South, distribution of electrical equipment MPE 64 provinces covering the whole territory of Vietnam, and not only in 3 countries Singapore, Laos, Cambodia but MPE will commit to expanding the market to many countries around the world.

Customer MPE brand known for high quality products, modern design, rich and diverse as: Conduit wires, electrical switches & sockets, lights, LED lights, Packing equipment cutting, electrical panels, plugs & sockets industrial so on As a manufacturer of electric appliances in Vietnam, MPE has constantly researched and developed to diversify products, brings to consumers high quality products and reasonable price.

All branded products MPE closely inspected by quality management system ISO 9001 advanced: 2008, with the advantages of modern production lines of Europe, the MPE has been created confidence in the engineers, design consultants, contractors and consumers in the last 10 years.

Warmest thanks and hope to get the cooperation of our customers.

MANH PHUONG ELECTRIC
General Director

NGUYEN TAM MANH

A20 SERIES



A20 SERIES



Safety & Beauty

Extra Convenience

MPE

1 To 6 Gang Standard Plate

MPE offer one to six gang switch plate in one standard plate. You can add in some more switches without adding an extra box. You can also have a lot of different combinations to meet your special requirement just by using a standard plate.



Easy Assembling

Just select the switch you need and push them into the plate. You can either put your plate vertically or horizontally but still maintain up and down switching action.

Easy Removal

Put a flat screw driver into the small gap of the locking position, slightly push the mechanism out by one finger from the front.



Standard Plate



A20 Series - Flush Socket 16A 2 Pin MPE



A201
1 Gang Plate



A202
2 Gang Plate



A203
3 Gang Plate



A204
4 Gang Plate



A205
5 Gang Plate



A206
6 Gang Plate



A201VX
Blank Plate



ASB
Safety Breaker Mounting Plate



AMCB1
Single Pole MCB Flush Plate



AMCB2
Double Pole MCB Flush Plate



A20KT
250V 20A DP Key Tag Switch

For Mechanism

Impact and fire resistant plates made of polycarbonate.
You can have 6 switches in one plate.

Designed to / IEC 669 - 1 : 1993
Dimension / 111,02 x 68,25 mm

All Sockets have got safety shutters to prevent your children from putting their fingers into the electricity carrying parts, as well as reducing dust going in.

Designed to / IEC 669 - 1 : 1993
Dimension / 111,02 x 68,25 mm



A20US
Single with Safety Shutter

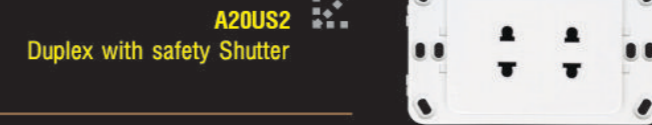

A20US2
Duplex with safety Shutter

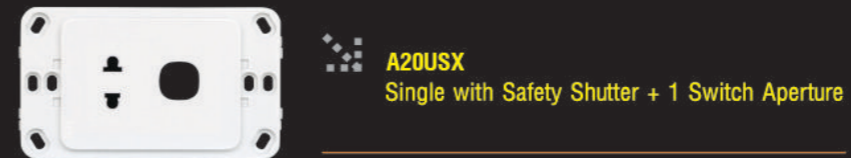

A20USX
Single with Safety Shutter + 1 Switch Aperture

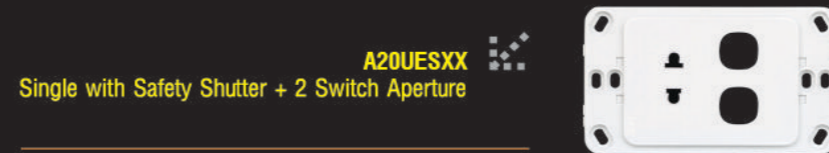

A20UESXX
Single with Safety Shutter + 2 Switch Aperture

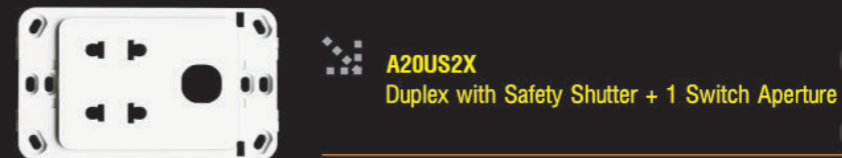

A20US2X
Duplex with Safety Shutter + 1 Switch Aperture

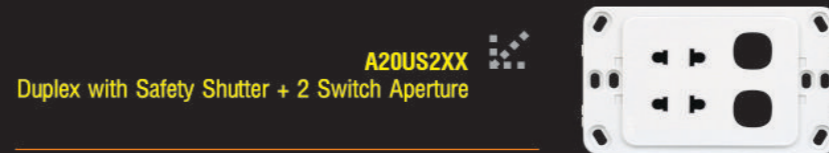

A20US2XX
Duplex with Safety Shutter + 2 Switch Aperture



A20US3
Triple with Safety Shutter

Flush Socket 16A 3 Pin



Decorating



All Sockets are fixed firmly by 3 screws on the plate. Your sockets would never fall into the metal box behind.

Designed to / IEC 669 - 1 : 1993
Dimension/ 111,02 x 68,25 mm



Interior Decoration

After finishing your interior decoration, select a surround, to match with your wall paint, furniture or your dream to make life more colourful. You can change the surround again at any time by yourself.

When decorating, surrounds can be removed enabling painting up to the edge of the grid assembly. There is no need to worry about overpainting, simply replace the surround for the perfect finish everytime.

A20-IP **New**

- A20US2M** Multi Function Socket
- A20UES** Single with Safety Shutter
- A20UES2** Duplex with safety Shutter
- A20UESX** Single with Safety Shutter + 1 Switch Aperture
- A20UESC** Duplex with safety Shutter
- A20UESXX** Single with Safety Shutter + 2 Switch Aperture



Extra Surround Color



Apart from safety & convenience, beauty is another thing you can be satisfied if you choose MPE.

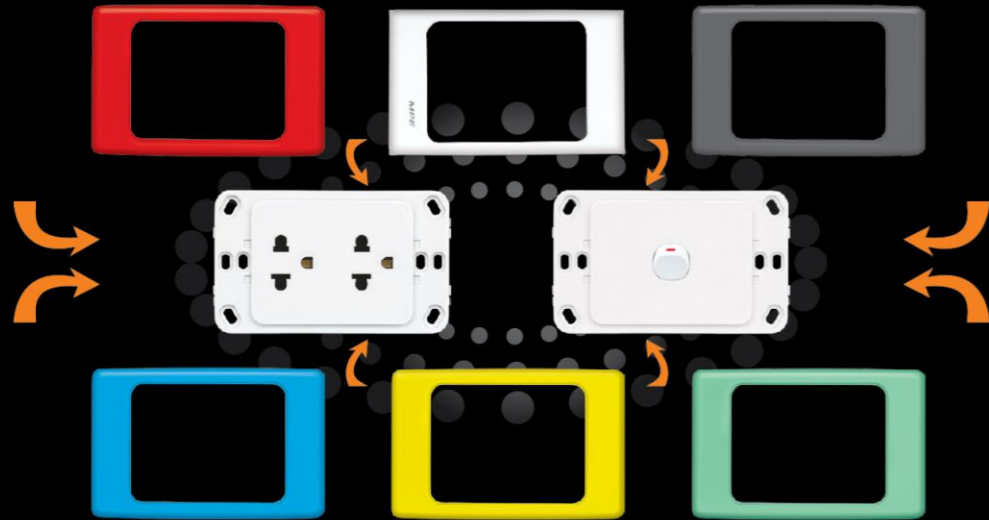

A20B-WE White - White electric colour surround	A20B-SG White - Soft grey colour surround	A20B-GY White - Cold grey colour surround	A20B-DG White - Dark grey colour surround
A20B-BK White - Glossy black colour surround	A20B-RD White - Hot red colour surround	A20B-NU White - Nutmeg brown colour surround	A20B-DS White - Desert sand colour surround
A20B-CM White - Warm cream colour surround	A20B-YL White - Bright yellow colour surround	A20B-GR White - Fresh green colour surround	A20B-BU White - Sky blue colour surround
A20B-DB White - Dark blue colour surround	A20B-TQ White - Turquoise colour surround	A20B-DO White - Dove grey colour surround	A20B-SH White - Silver shadow colour surround
A20-IP New White Colour surround Iphone	A20B-BY White - Burgund colour surround	A20-WN White Colour surround	

Key Tag Switch



Key Tag Switch

Using MPE's A20 Series key tag switch is an effective way of energy management for hotels and other locations where power can be left out unnecessarily. Inserting the key tag into the switch wich activates selected circuits to operate lighting, air conditioning, television, etc... Removing the key tag, power will automatically cut off. It's an ideal way for energy saving.

A30 SERIES



A30 SERIES

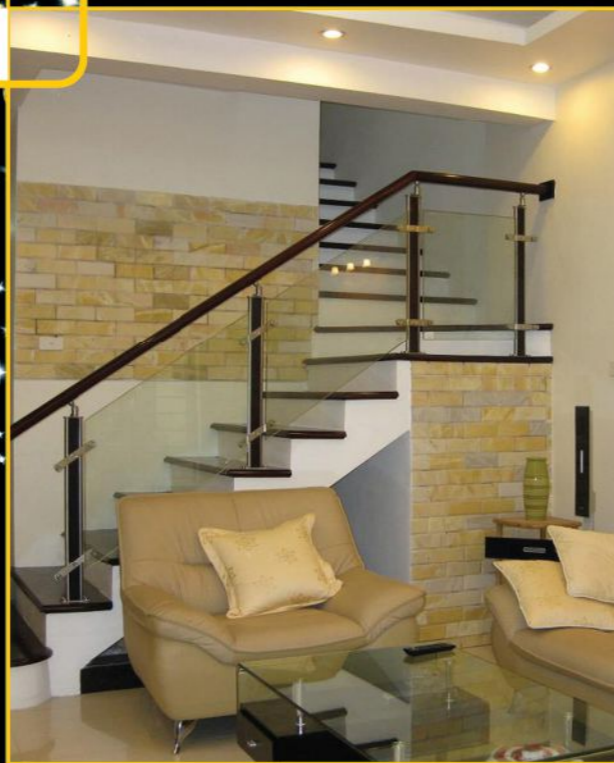

Safety & Beauty



A301
1 Gang plate



A302
2 Gang plate

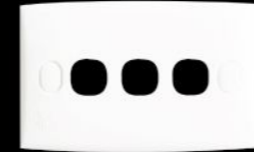

A303
3 Gang plate



A304
4 Gang plate

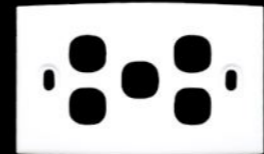

A305
5 Gang plate

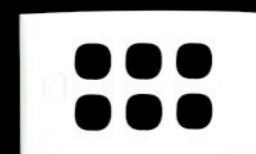

A306
6 Gang plate



A301VX
Blank Plate



A30SB
Safety breaker mounting plate



A30MCB1
Single pole MCB flush plate



A30MCB2
Double pole MCB flush plate



A223V
Waterproof cover for plate
& socket



A223
Waterproof cover for plate
& socket



For Mechanism

Impact and fire resistant plates made of polycarbonate.
You can have 6 switches in one plate.

Designed to / IEC 669 - 1 : 1993
Dimension / 115,02 x 77,66 mm

A30 Series - Flush Socket 16A 2 Pin **MPE**

Designed to / IEC 669 - 1 : 1993
Dimension / 115,02 x 72,66 mm



A30US
Single with Safety Shutter



A30US2
Duplex with safety Shutter

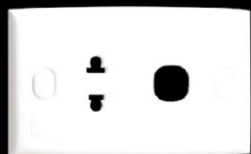

A30USX
Single with Safety Shutter + 1 Switch Aperture



A30USXX
Single with Safety Shutter + 2 Switch Aperture



A30US2X
Duplex with Safety Shutter + 1 Switch Aperture



A30US2XX
Duplex with Safety Shutter + 2 Switch Aperture



A30US3
Triple with Safety Shutter

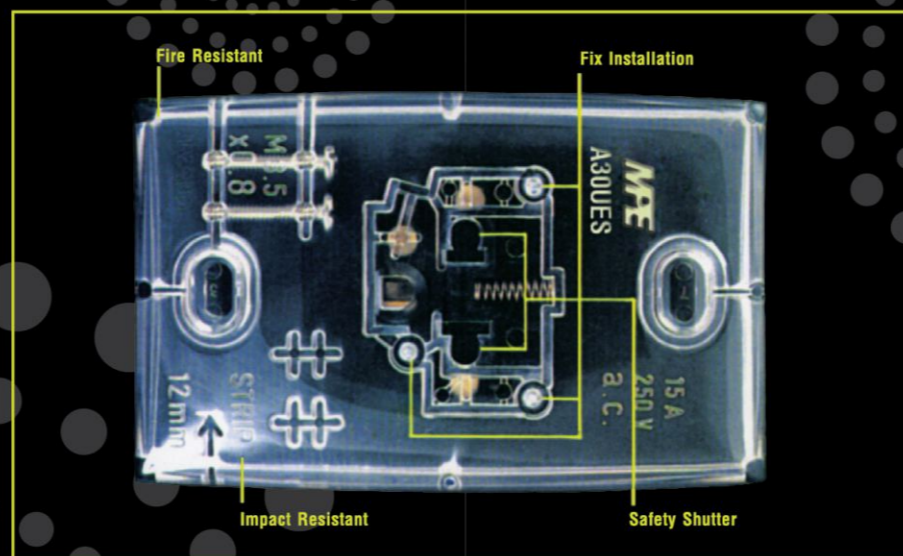

Impact Resistant

MPE use high impact resistant plastic called polycarbonate for the facia plate. A broken switch or socket is very dangerous to yourself or your family.

A30 Series - Flush Socket 16A 3 Pin **MPE**

Designed to / IEC 669 - 1 : 1993
Dimension / 115,02 x 72,66 mm



A30US2M
Multi Function Socket

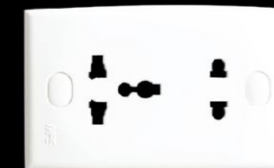

A30UES
Single with Safety Shutter



A30UES2
Duplex with Safety Shutter



A30UESX
Single with Safety Shutter + 1 Switch Aperture



A30UESC
Single with safety shutter + 1 Switch



A30UESXX
Single with Safety Shutter + 2 Switch Aperture

Safety Shutter

All MPE universal sockets are fitted with safety chutters. Even your child is playing around with the sockets with his finger or any metal parts, he can hardly put things into the socket holes and get in touch with the electricity carrying parts.

MECHANISM



Fire Resistant

MPE use high quality plastic which are fire resistant. In case of short circuit or overload, you do not have to worry your switches and sockets causing fire in your house, office or factory.

MECHANISM



- 

A30USB
USB charger sockets
- 

A30/1/2M-1D
10A 1 Way Switch
- 

A30MD20
20A DP Switch
- 

A30M
10A 2 Way Switch
- 

A30NRD
Neon Indicator (Red colour)
- 

A30NGN
Neon Indicator (Green colour)
- 

A30RJ64
4 Wire Telephone Socket
- 

A30RJ88
8 Wire Telephone Socket
- 

AV 600
600VA - 220VAC Fan Control
- 

AV 800
800W - 220VAC Dimmer
- 

AV 1200
1.200W - 220VAC Dimmer
- 

A30MBP
3A Bell Push Switch
- 

A30TV75
75 Ohm TV/FM Co Axial Socket
- 

AVH
Oval Screw Cap
- 

A30P
Blank Removable Cap
- 

AKT
Key Tag for A20KT
- 

A157N
Plastic Flush Box
- 

A157 MCB
Plastic Flush Box For MCB
- 

A157S
Metal Flush Box
- 

AK 2237
Plastic Surface Box



A 157ND
Twin plastic flush box

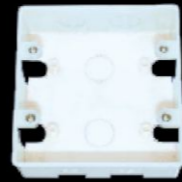

A 157N2
Twin plastic flush box



AKSB
Plastic box SB



A157V2
Plastic flush box
England style



AK 237
Plastic Surface Box



AC157N
Cover Flush Box



A 157V
File-resistant Material
Square Single Flush Box



A 6K01
Plastic surface box for seri A60



A 6K02
Plastic surface box for seri A60



AK2237N
Plastic Surface box

A50 SERIES



A50 SERIES

+ characteristics

The switch is designed with large key luxury, convenience to the user. There are 3 different size switch (the key, medium key and primary key) easy for customers to choose.

The surface switch is manufactured from flame retardant polycarbonate, shiny and resistant to impact.

The base made from high-grade plastic PA, fire resistant.

Next point is made of silver-plated copper alloy increases the likelihood of exposure and electrical conductivity, corrosion-resistant and highly reliable, highly secure.

Assisted with spring contact structure horizontal vibrations make the switch softly

Screws tighten the wire is made of copper alloy, high hardness, not the teeth flush installation.

The switch is designed in modular form, convenient for user selection and installation.

Voltage: 250V AC

Rated Current: 16A

Is produced according to IEC 60669-1

+ Application:

Switches big key format is commonly used for Series A50, Series 60 Series A70 & A80 Series.

Used for many types of equipment: lights, fans, computers, TVs ...

Consistent with civil buildings, hotels, villas, apartments, hospitals, schools ...

Safety & Beauty

Designed to / IEC 60669 - 2 - 1 : 2002
Dimension / 120 x 70 mm



A501
1 Gang Flush Plate



A502
2 Gang Flush Plate



A503
3 Gang Flush Plate

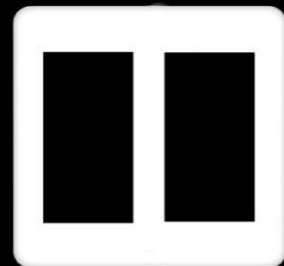

A50456
Twin Flush Plate



A50SB
Safety Breaker mounting plate



A50MCB2
Double pole MCB flush plate



A50MCB1
Single pole MCB flush plate

A60 SERIES

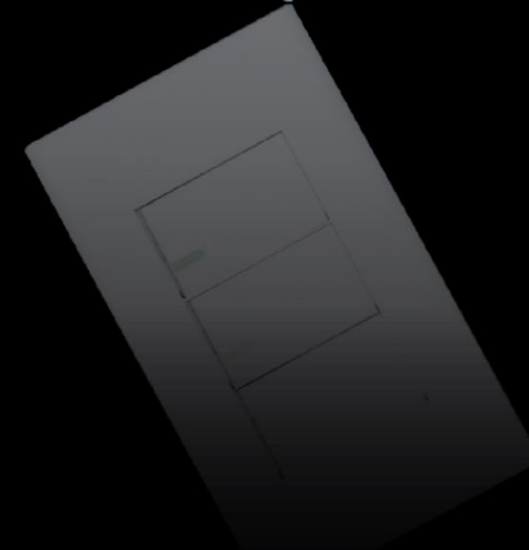

A60 SERIES

+ characteristics

The switch is designed with large key luxury, convenience to the user. There are 3 different size switch (the key, medium key and primary key) easy for customers to choose.
The surface switch is manufactured from flame retardant polycarbonate, shiny and resistant to impact.
The base made from high-grade plastic PA, fire resistant.
Next point is made of silver-plated copper alloy increases the likelihood of exposure and electrical conductivity, corrosion-resistant and highly reliable, highly secure.
Assisted with spring contact structure horizontal vibrations make the switch softly
Screws tighten the wire is made of copper alloy, high hardness, not the teeth flush installation.
The switch is designed in modular form, convenient for user selection and installation.
Voltage: 250V AC
Rated Current: 16A
Is produced according to IEC 60669-1

+ Application:

Switches big key format is commonly used for Series A50, Series 60 Series A70 & A80 Series.
Used for many types of equipment: lights, fans, computers, TVs ...
Consistent with civil buildings, hotels, villas, apartments, hospitals, schools ...

Safety & Beauty

Standard Plate/ Flush Socket/ Mechanism **MPE**

Designed to / IEC 60669 - 2 - 1 : 2002
Dimension / 120 x 70 mm



A601
1 Gang Flush Plate



A602
2 Gang Flush Plate



A603
3 Gang Flush Plate



A60456
Twin Flush Plate



A60SB
Safety Breaker mounting plate



A60MCB1
Double pole MCB flush plate



A60MCB2
Double pole MCB flush plate

Mechanism A50, A60 **MPE**

MPE



A6USB
USB charger sockets



A6US
2-Pin socket with shutter



A6UES2
3-pole Socket Double with Shutter



A6UESM
Multifunction Socket with Shutter



A6M/1
1 Way Switch



A6M/2
2 Way Switch



A6NGN
Neon Indicator (Green Color)



A6NRD
Neon Indicator (Red Color)



A6P
Blank removable cap



A6F
Fuse 10A



A6RJ64
4 Wire Telephone Socket



A6RJ88
8 Wire Lan Socket



A6TV75
75 Ohm TV/FM Co Axial Socket



A6V800L
800W-220VAC Dimmer



A6V1200L
1200W-220VAC Dimmer



A6V800F
800W-220VAC Fan control



A6MBP
3A Bell Push Switch



A70 SERIES

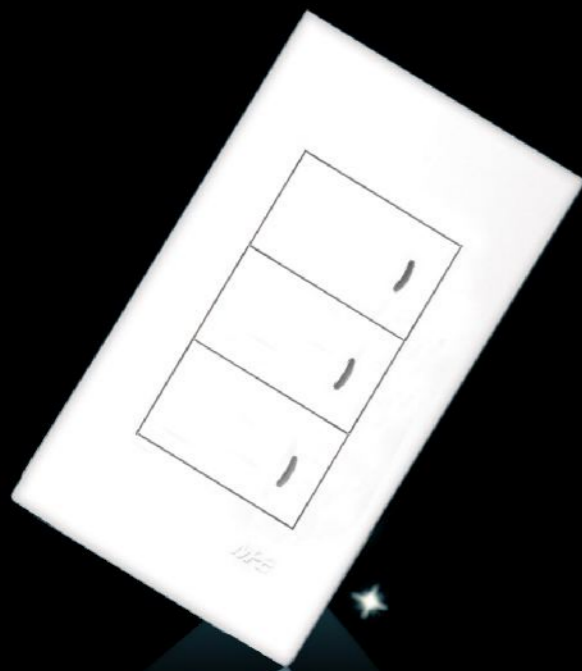

A70 SERIES

+ Features:

Sockets are designed with luxurious style and high level of safety for users.

The surface switch is manufactured from flame retardant polycarbonate, shiny and resistant to impact.

The base made from high-grade plastic PA, fire resistant.

Pin socket is made of copper alloy with high elasticity, along with semicircular structure helps hold the socket and good contact with the plug.

There are safety cover (safety shutter) to dust cover and safety for users and children.

Plugs are designed as modular, easy to use and install option.

Voltage: 250V AC

Rated Current: 16A

Is produced according to IEC 60884-1

+ Application:

Used for many types of equipment: lights, fans, computers, TVs ...

Consistent with civil buildings, apartments, hospitals, schools ...

Safety & Beauty

Designed to / IEC 60669 - 2 - 1 : 2002
Dimension / 120 x 70 mm



A701
1 Gang flush plate

A702
2 Gang flush plate



A703
3 Gang flush plate

A70SB
Safety breaker mounting plate

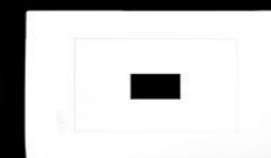

A70456
Twin flush plate

A70MCB1
Double pole MCB flush plate



A70MCB2
Double pole MCB flush plate

P223V
Water proof cover

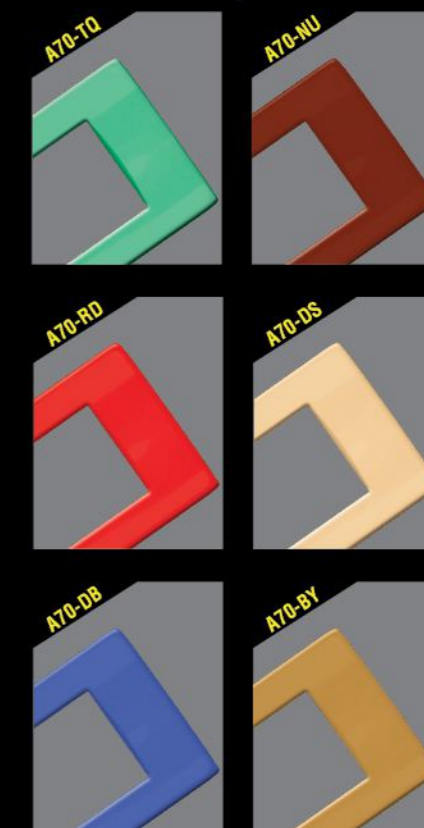



A80 SERIES

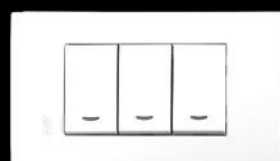
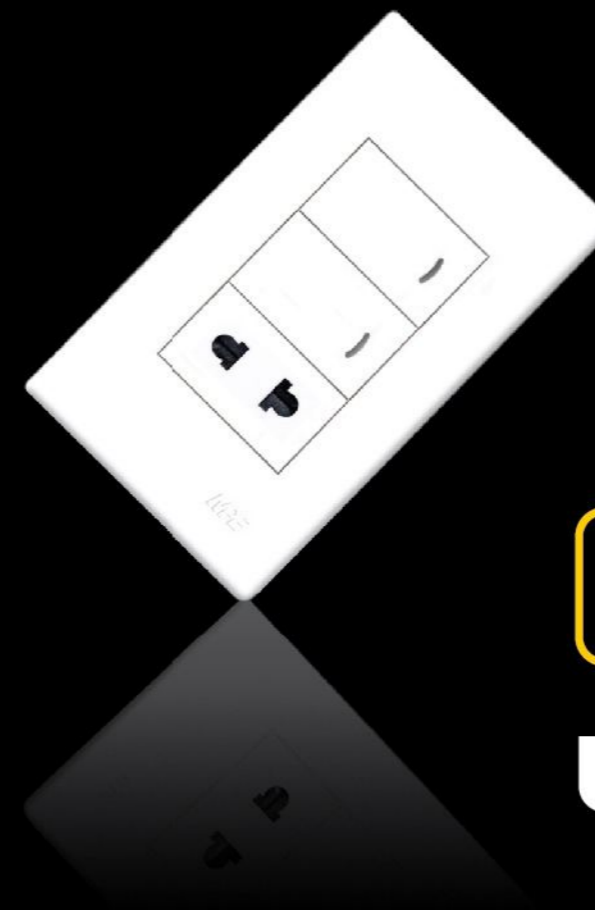

3 Gang 1-way switch function key



Dimmer switch

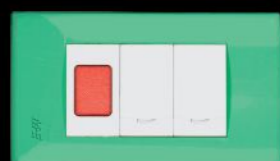

2 Gang 1 Way Switch With 1 Neon Indicator



2 Pin Double Sockets

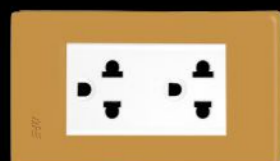

3 Pin Double sockets



Telephone socket outlet with Tivi socket outlet

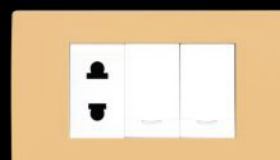

2 Gang 1 Way Switch With 2 Pin Sockets



A80 SERIES

+ Features:

Sockets are designed with luxurious style and high level of safety for users.
 The surface switch is manufactured from flame retardant polycarbonate, shiny and resistant to impact.
 The base made from high-grade plastic PA, fire resistant.
 Pin socket is made of copper alloy with high elasticity, along with semicircular structure helps hold the socket and good contact with the plug.
 There are safety cover (safety shutter) to dust cover and safety for users and children.
 Plugs are designed as modular, easy to use and install option.
 Voltage: 250V AC
 Rated Current: 16A
 Is produced according to IEC 60884-1

+ Application:

Used for many types of equipment: lights, fans, computers, TVs ...
 Consistent with civil buildings, apartments, hospitals, schools ...

Safety & Beauty

Designed to / IEC 60669 - 2 - 1 : 2002
Dimension / 120 x 70 mm



A801
1 Gang flush plate



A802
2 Gang flush plate



A803
3 Gang flush plate

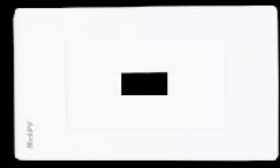

A80SB
Safety breaker mounting plate



A80MCB1
Single pole MCB flush plate



A80MCB2
Single pole MCB flush plate

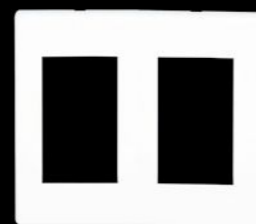

A80456
Twin flush plate



BKT
16A saving switch with time delay on-off switch



A70KT
16A saving switch with time delay on-off switch

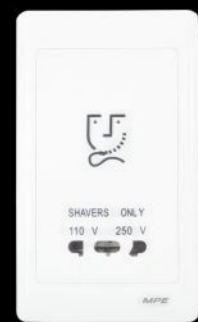

A727
100/250V Shaver Socket, Vertical



AMBP
3A Bell Push Switch



B727
110/250V shaver socket

A90 SERIES



A90 SERIES

+ Features:

Sockets are designed with luxurious style and high level of safety for users. The surface switch is manufactured from flame retardant polycarbonate, shiny and resistant to impact. The base made from high-grade plastic PA, fire resistant. Pin socket is made of copper alloy with high elasticity, along with semicircular structure helps hold the socket and good contact with the plug. There are safety cover (safety shutter) to dust cover and safety for users and children. Plugs are designed as modular, easy to use and install option. Voltage: 250V AC
Rated Current: 16A
Is produced according to IEC 60884-1

+ Application:

Used for many types of equipment: lights, fans, computers, TVs ...
Consistent with civil buildings, apartments, hospitals, schools ...















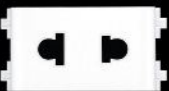













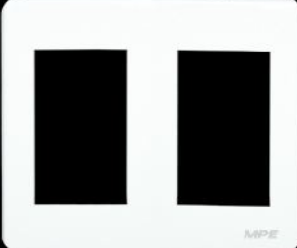

Safety & Beauty

Standard Plate/ Flush Socket/ Mechanism **MPE**

Designed to / IEC 60669 - 2 - 1 : 2002
Dimension / 120 x 70 mm



A70/ A80/A90 Series Mechanism **MPE**

 AUSB USB charger sockets	 FS Fuse 10A	 AK01 Plastic surface box	 AK02 Twin plastic surface box	 AUS 2-Pin socket with shutter
 AUES 2-Pin socket with shutter	 AUES2 Twin 2-Pin socket with shutter	 AUESM Multi Function Socket	 AM/1 1-way Switch	
 AM/2 2-way Switch	 ATV75 75 Ohm co-axial outlet mechanism	 AP Standard-sized removable over plate	 ARJ64 Telephone outlet with shutter	
 A901 1 Gang Flush Plate	 A602 2 Gang Flush Plate	 ARJ88 Data outlet with shutter	 ANGN Green Neon Indicator	 ANRD Red Neon Indicator
 A903 3 Gang Flush Plate	 A90456 Twin Flush Plate	 A70MBP/ A80MBP Bell Switch Mechanism	 AMD20 20A DB Switch	 A800L Dimmer mechanism with rotary on/off
 A90SB Safety Breaker mounting plate	 A90MCB1 Single pole MCB flush plate	 A800F Fan speed controller with rotary on/off	 A78F Fuse 10A	
 A90MCB2 Double pole MCB flush plate		 AM/1M 1 Way switch size M	 AM/2M 2 Way switch size M	 AM/1L 1 Way switch
			 AM/2L 2 Way switch	

B20 SERIES

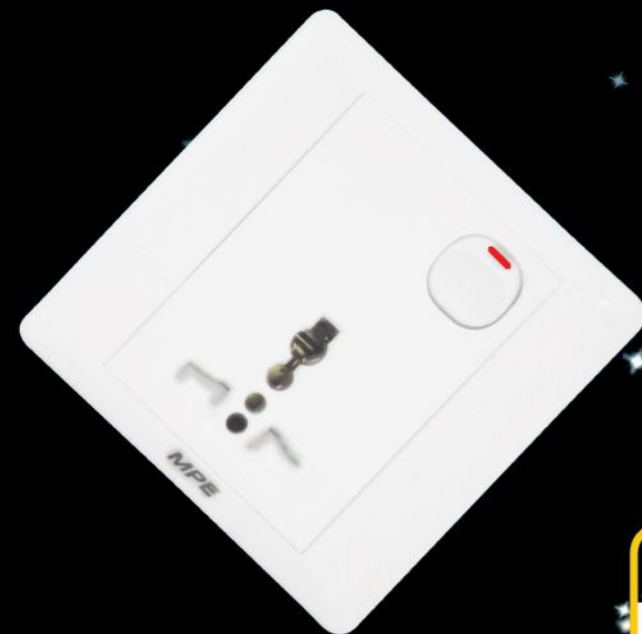

B20 SERIES

Constructed with state-of-the-art polycarbonate (PC) material, the B20 series is designed to withstand impact, heat and corrosion, making it totally safe and reliable. Its simple, slim, cured form adds elegant to a design that's built to stand the test of time.

Attractive and easy to install, the B20 Series meets the aesthetic and functional needs of the modern home. Home-owners will love distinctive personality.

Safety & Beauty

Socket/ Gang



B201
1 Gang flush plate



B202
2 Gang flush plate



B203
3 Gang flush plate



B204
4 Gang flush plate



B2UESM
Multifunction Socket with 1 Gang



B215S
Square Socket Shutter with 1 Gang



B2US
2-pole Socket with Shutter



B2USX
2-pole Socket with 1 Gang



B2US2
Double 2-pole Socket with Shutter



B2DD1
"Do Not Disturb" Plate and Bell Push Switch



DBP
Nút nhấn chuông kín nước



DBP
Door bell



N04
Plastic wall box for shaver socket



N06
Plastic wall box for shaver socket



B2TDS
Touch delay Switch

Floor Sockets / Accessories

MPE



FA
Ash-grey Floor Recessed Socket



FY
Yellow Floor Recessed Socket



FB
Black Floor Recessed Socket



FW
White Floor Recessed Socket

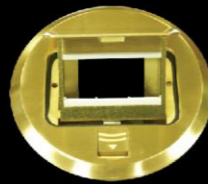

FCY
Yellow Circle Floor Recessed Socket



FCA
Ash-grey Circle Floor Recessed Socket



FUSB
USB charger sockets



FUS
Floor Single 2-Pin socket



FUSM
Floor multifunction socket



FUES2
Floor double 3-pin socket



FTV75
Floor TV socket



FRJ64
Floor telephone socket

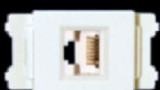

FRJ88
Floor Lan net socket

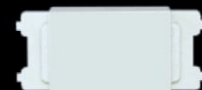

FP
Floor smooth covered button



F115
Iron stand for floor socket

Floor Sockets Plastic / Accessories

MPE



FGP
Sound floor socket
3-hole round plastic style



A6USB
USB charger sockets



A6US
2-pole socket with shutter



F6UES2
3-pole socket with shutter



A6TV75
75 Ohm TV Axial socket



A6RJ64
4 wire telephone socket



F6RJ88
8 wire Lan socket



A6UESM
Multifunction socket with chutter



A6P
Blank removable cap

Multi - Function Socket wire

MPE



AM3S
Multi-Function Socket wire



AM5S
Multi-Function Socket wire with Fuse

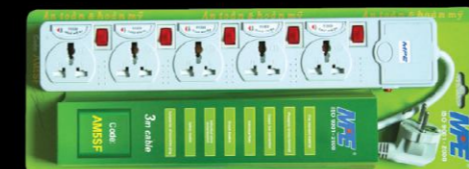

AM5SF
Multi-Function Socket wire with Fuse

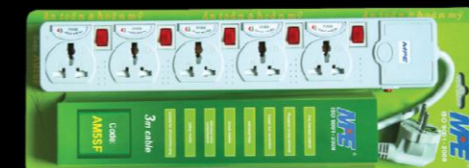

AM5SFB
Multi-Function Socket wire



TA1
Travel Adapter



TA2
Travel Adapter with USB



TA3
Travel Adapter with USB



AD1
Travel Adapter

Exit and Emergency Lighting

MPE



EML
Emergency lighting

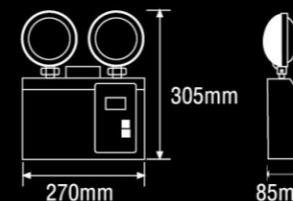

- EX** Exit lighting
- EXL** Exit door on left
- EXR** Exit door on right
- EXLR** Exit door 1 surface on left and right
- EX2** Exit door on left 2 surface
- EX2LR** Exit door 2 surface on left and right

- Design for the harsh condition
- Suitable for machine industry, factory and construction
- There is ability for heat-resistant and high electrical insulation



Fixed plug with wire-clip

- MPN-013**
16A-240V-2P+E-IP44
- MPN-023**
32A-240V-2P+E-IP44
- MPN-015**
16A-380V-415V-3P+N+E-IP44
- MPN-014**
16A-380V-415V-3P+E-IP44
- MPN-024**
32A-380V-415V-3P+E-IP44
- MPN-025**
32A-380V-415V-3P+N+E-IP44
- MPN-0342**
63A-380V-415V-3P+E-IP67
- MPN-0352**
63A-380V-415V-3P+N+E-IP67
- MPN-044K**
125A-380V-415V-3P+E-IP67

Fixed socket install on the electrical board

- MPN-313**
16A-240V-2P+E-IP44
- MPN-323**
32A-240V-2P+E-IP44
- MPN-315**
16A-380V-415V-3P+N+E-IP44
- MPN-314**
16A-380V-415V-3P+E-IP44
- MPN-324**
32A-380V-415V-3P+E-IP44
- MPN-325**
32A-380V-415V-3P+N+E-IP44
- MPN-3342**
63A-380V-415V-3P+E-IP67
- MPN-4352**
63A-380V-415V-3P+N+E-IP67
- MPN-3452**
125A-380V-415V-4P+E-IP67

Portable connector with wire-clip

- MPN-1013**
16A-6h/220-250V-IP44
- MPN-213**
16A-240V-2P+E-IP44
- MPN-223**
32A-240V-2P+E-IP44
- MPN-214**
16A-380V-415V-3P+E-IP44
- MPN-224**
32A-380V-415V-3P+E-IP44
- MPN-2342**
63A-380V-415V-3P+E-IP67

Socket type fixed wall mount

- MPN-113**
16A-240V-2P+E
- MPN-123**
32A-240V-2P+E
- MPN-115**
16A-380V-415V-3P+N+E-IP44
- MPN-114**
16A-380V-415V-3P+E
- MPN-124**
32A-380V-415V-3P+E
- MPN-125**
32A-380V-415V-3P+N+E-IP44
- MPN-1342**
63A-380V-415V-3P+E
- MPN-1352**
63A-380V-415V-3P+N+E-IP67

Isolator-IP66

- SW-120**
20A-250V-1P
- SW-132**
32A-250V-1P
- SW-220**
20A-500V-2P
- SW-232**
32A-500V-2P
- SW-263**
63A-500V-2P
- SW-320**
20A-500V-3P
- SW-332**
32A-500V-3P
- SW-363**
63A-500V-3P

Combination switched sockets-IP66



- S-315**
15A-250V-3P
- S-332**
32A-250V-3P

Industrial-Plug-IP66



- P-315**
15A-250V-3P
- P-332**
32A-250V-3P

Flush Mounted Metal Consumer Unit/ E Series



Flush Mounted Metal Consumer Unit	Dimension (W x W1 x H x H1 x D) mm
2P Consumer Unit	126 x 136 x 200 x 210 x 58
3P Consumer Unit	126 x 136 x 200 x 210 x 58
4P Consumer Unit	126 x 136 x 200 x 210 x 58
6P Consumer Unit	170 x 180 x 200 x 210 x 58
9P Consumer Unit	232 x 242 x 200 x 210 x 58
13P Consumer Unit	305 x 315 x 200 x 210 x 58
18P Consumer Unit	395 x 405 x 200 x 210 x 58

Dimension

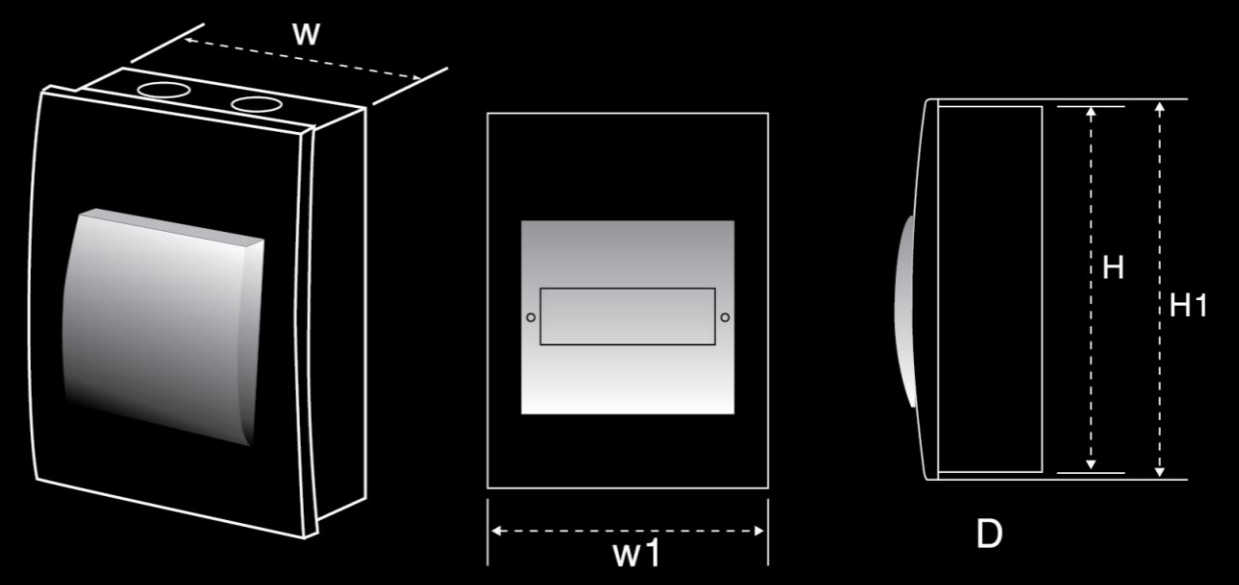



Flush Mounted Metal Consumer Unit	Dimension (A x B x C x D x H1 x H2) mm
T4 Consumer Unit	148 x 160 x 128 x 135 x 90 x 70
T6 Consumer Unit	215 x 199 x 188 x 170 x 95 x 76
T10 Consumer Unit	287 x 213 x 258 x 185 x 95 x 76
T14 Consumer Unit	362 x 248 x 330 x 216 x 95 x 76
T20 Consumer Unit	470 x 248 x 440 x 216 x 105 x 85
T24 Consumer Unit	323 x 382 x 300 x 355 x 105 x 85
T32 Consumer Unit	398 x 500 x 365 x 460 x 115 x 95
T40 Consumer Unit	470 x 500 x 440 x 460 x 115 x 95

Dimension

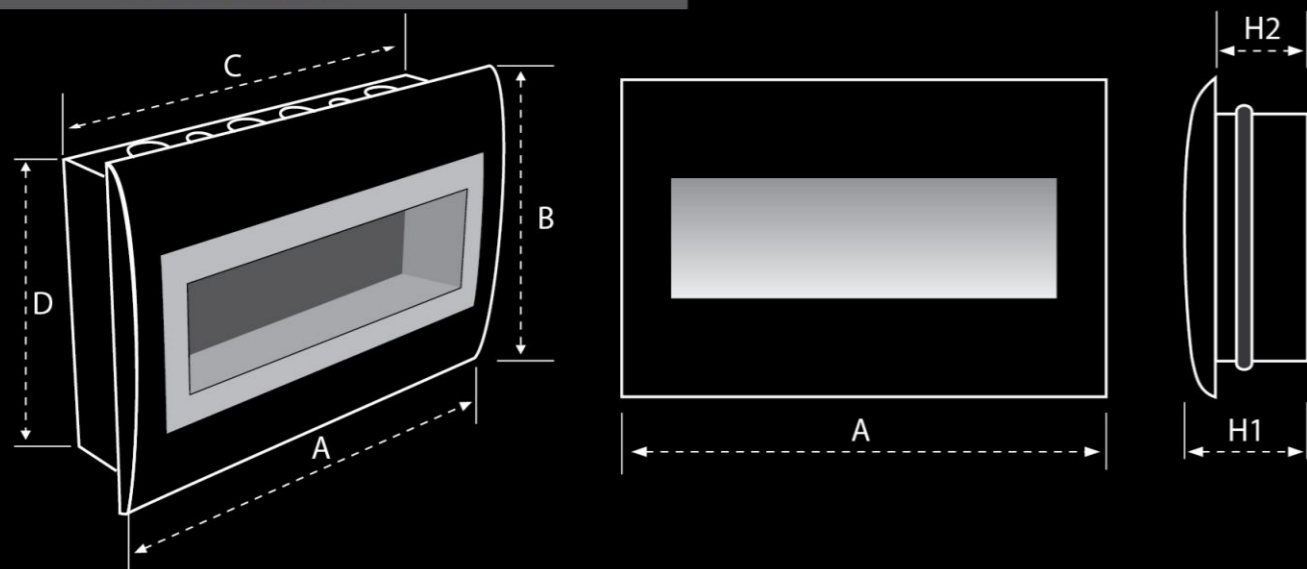

Particularity

- Conform to standard BS 5486-1.
- Available in 1 to 18 ways.
- The body is made of powder-coated steel.
- The cover is made of polycarbonat.
- Accessories: busbar, neutral terminal, guidance information.
- Incoming and outgoing ways available.



AF-150 - Wall exhaust

- Dimension: 150mm
- Power: 30Watt
- Air Delivery 4.8m³/min
- Voltage 220 Volt
- Cut out 200mm x 200mm

AFS-150 -Wall exhaust

- Dimension: 150mm
- Power: 30Watt
- Air Delivery 4.8m³/min
- Voltage 220 Volt
- Cut out 200mm x 200mm

AF-200 - Wall exhaust

- Dimension: 200mm
- Power: 35Watt
- Air Delivery 8.1m³/min
- Voltage 220 Volt
- Cut out 250mm x 250mm

AFS-200 -Wall exhaust

- Dimension: 200mm
- Power: 35Watt
- Air Delivery 8.1m³/min
- Voltage 220 Volt
- Cut out 250mm x 250mm

AF-250 - Wall exhaust

- Dimension: 250mm
- Power: 40Watt
- Air Delivery 12.6m³/min
- Voltage 220 Volt
- Cut out 305mm x 305mm

AFS-250 -Wall exhaust

- Dimension: 250mm
- Power: 40Watt
- Air Delivery 12.6m³/min
- Voltage 220 Volt
- Cut out 305mm x 305mm

AFC-130 - Ceiling exhaust



- Dimension: 130mm
- Power: 30Watt
- Air Delivery 4.8m³/min
- Voltage 220 Volt
- Cut out 200mm x 200mm

PVC CONDUITS & FITTINGS



PVC CONDUITS & FITTINGS

Features:

- Hard PVC Conduit is made from high quality PVC production BSEN-50086-2-1 standard.
- PVC pipes have 2 categories: Medium Duty (withstand compressive forces 750N) and Heavy Duty (withstand compressive forces 1250N).
- PVC pipes with Vietnam following the best properties:
 - + Withstands high compressive strength: not crack or break when installed in wall, floor and underground sounds.
 - + Resistant to bumps
 - + The High Flexibility: Easily bend at will, can bend 90°.
 - + Good insulation: withstand voltage up to 2,000V
 - + Self fire: no flaming direct combustion, flame extinguished itself in less than 30 seconds duration.
 - + Anti-corrosive and anti-UV

Application:

- + Used for installation in the building: floating ceiling installation, sound walls, concrete floor or buried.
- + Used in places requiring high impact, fire retardant, anti-corrosion and insulation ...

PVC Conduits

CAT. NO.	Description	CAT. NO.	Description	Designed To
A9016	PVC conduit	A9016HV	PVC conduit	BS EN 50086 2-1:1996
A9020	PVC conduit	A9020HV	PVC conduit	
A9025	PVC conduit	A9025HV	PVC conduit	
A9032	PVC conduit	A9032HV	PVC conduit	

PVC Screwed Coupling



CAT. NO.	Description	Designed To
	20mm screwed coupling & male bush	BS 4607 Part 1: 1984 Part 5: 1982
	25mm screwed coupling & male bush	
	32mm screwed coupling & male bush	

PVC Joining Coupling



CAT. NO.	Description	Designed To
	16mm joining coupling	BS 4607 Part 1: 1984 Part 5: 1982
	20mm joining coupling	
	25mm joining coupling	
	32mm joining coupling	
	20-16mm joining coupling	

PVC Conduit Clip



CAT. NO.	Description	Designed To
	16mm conduit clip	
	20mm conduit clip	
	25mm conduit clip	
	32mm conduit clip	

Others



CAT. NO.	Description	Designed To
	Lid for junction box	



Safety & Beauty

PVC Conduits & Fittings



Flexible Conduit - 50m/Coil



PVC Surface Juntion Box

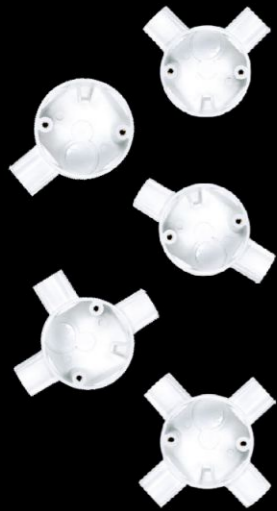

CAT. NO.	Description	Designed To
	20mm 1 way juntion box	BS 4607
	20mm 2 ways juntion box	
	20mm 2 ways angle juntion box	
	20mm 3 ways juntion box	
	20mm 4 ways juntion box	
	25mm 1 way juntion box	
	25mm 2 ways juntion box	
	25mm 2 ways angle juntion box	
	25mm 3 ways juntion box	
	25mm 4 ways juntion box	



Description	Code	Packing
Corrugated conduit Ø16	A 9016CM	50m/ Coil
Corrugated conduit Ø20	A 9020CM	50m/ Coil
Corrugated conduit Ø25	A 9025CM	50m/ Coil
Corrugated conduit Ø32	A 9032CM	25m/ Coil

PVC Surface Ins ection Elbow

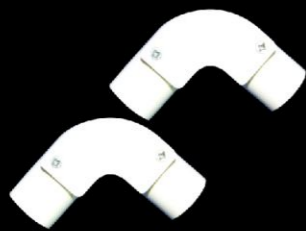

CAT. NO.	Description	Designed To
	20mm inspection elbow	BS 4662
	25mm inspection elbow	BS 4568
	32mm inspection elbow	

PVC Surface Inspection Tee



CAT. NO.	Description	Designed To
	20mm inspection tee	BS 4662
	25mm inspection tee	BS 4568
	32mm inspection tee	

PVC Adaptable Box



CAT. NO.	Description	Designed To
	(80 x 80 x 43) mm adaptable box	BS 4662
	(100 x 100 x 49) mm adaptable box	BS 4568
	(151 x 151 x 53) mm adaptable box	

PVC - Proof PVC Trunking



Description	Code	Packing
Cable Trunking 20x10(2m/c)	MP 20/10	25 piece/package
Cable Trunking 25x14(2m/c)	MP 25/14	25 piece/package
Cable Trunking 30x16(2m/c)	MP 30/16	25 piece/package
Cable Trunking 40x22(2m/c)	MP 40/25	25 piece/package
Cable Trunking 50x35(2m/c)	MP 50/35	25 piece/package
Cable Trunking 60x40(2m/c)	MP 60/40	25 piece/package
Cable Trunking 80x50(2m/c)	MP 80/50	10 piece/package
Cable Trunking 100x60(2m/c)	MP 100/60	6 piece/package
Cable Trunking 100x40(2m/c)	MP 100/40	6 piece/package

Downlight



Description	Code
Downlight 3 inch	DL-3
Downlight 3.5 inch	DL-3.5
Downlight 4 inch	DL-4

LED LIGHTING



LED BULB

LED TUBE



Model	Power	Lumen (lm)	Base Type	SIZE (mm)
LB-3T LB-3V	3W	250	E27	45 x 77
LBS-5T LBS-5V	5W	365	E27	50 x 95
LB-5T LB-5V	5W	340	E27	60 x 112
LB-7T LB-7V	7W	650	E27	60 x 112
LB-9T LB-9V	9W	820	E27	60 x 112

Model	Power	Lumen (lm)	Color Temperature	Size
LT8-60T LT8-60V	10W	830	5500-6500K 2700-3200K	599 x 26±1mm
LT8-120T LT8-120V	20W	1703	6000-6500K 2700-3200K	1198 x 26±1mm

BATTEN LED TUBE



Model	Power	Size
EMDK-118	1X18W	599 x 26±1mm
EMDK-218	2X18W	599 x 26±1mm
EMDK-136	1X36W	1198x 26±1mm
EMDK-236	2X36W	1198x 26 1mm

BATTEN LED TUBE



Model	Power	Voltage	Size
MLT-110	1X10W	AC85-265V/50Hz-60Hz	599 x 26±1mm
MLT-210	1X20W	AC85-265V/50Hz-60Hz	599 x 26±1mm
MLT-120	2X10W	AC85-265V/50Hz-60Hz	1198 x 26 ±1mm
MLT-220T	2X20W	AC85-265V/50Hz-60Hz	1198 x 26 ±1mm

LED PANEL

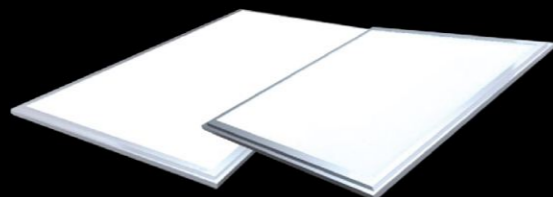

Model	Power	Lumen	Color Temperature	Voltage	Size (mm)
FPL-3030T FPL-3030V	20W	1300	6000±5000K 2700±3200K	100-240VAC/50Hz-60Hz	300 x 300 x 13
FPL-6030T FPL-6030V	30W	2000	6000±5000K 2700±3200K	100-240VAC/50Hz-60Hz	600 x 300 x 13
FPL-6060T FPL-6060V	36W	2800	6000±5000K 2700±3200K	100-240VAC/50Hz-60Hz	600 x 600 x 13
FPL-12030T FPL-12030V	36W	2800	6000±5000K 2700±3200K	100-240VAC/50Hz-60Hz	1200 x 300 x 13
FPL-12060T FPL-12060V	80W	5400	6000±5000K 2700±3200K	100-240VAC/50Hz-60Hz	1200 x 600 x 13

LED LIGHTING



LED round panel



Model	Power	Lumen (lm)	Size (mm)	Cut out (mm)
RPL-6T RPL-6V	6W	486	120 x 25	105 x 105
RPL-9T RPL-9V	9W	720	150 x 25	130 x 130
RPL-12T RPL-12V	12W	932	170 x 25	150 x 150
RPL-15T RPL-15V	15W	1150	190 x 25	180 x 180
RPL-18T RPL-18V	18W	1350	225 x 25	205 x 205



LED square panel

Model	Power	Lumen (lm)	Size (mm)	Cut out (mm)
SPL-6T SPL-6V	6W	486	120 x 120	105 x 105
SPL-9T SPL-9V	9W	720	150 x 150	130 x 130
SPL-12T SPL-12V	12W	932	170 x 170	150 x 150
SPL-15T SPL-15V	15W	1150	190 x 190	180 x 180
SPL-18T SPL-18V	18W	1350	225 x 225	205 x 205

LED round panel Surface



Model	Power	Lumen (lm)	Size (mm)
SRPL-6T SRPL-6V	6W	484	120 x 35
SRPL-12T SRPL-12V	12W	918	180 x 35
SRPL-18T SRPL-18V	18W	1350	225 x 35



LED square panel Surface

Model	Power	Lumen (lm)	Size (mm)
SSPL-6T SSPL-6V	6W	484	120 x 25
SSPL-12T SSPL-12V	12W	918	180 x 25
SSPL-18T SSPL-18V	18W	1350	225 x 25

LED Downlight



Model	Power	Lumen (lm)	Color Temperature	LED	Light	Voltage	Size (mm)	Cut out (mm)
LD-3T LD-3V	3W	270lm	5700-6500K 2700-3200K	3x1W	60°	AC85 - 365V 50/60Hz	90 x 50	75
LD-5T LD-5V	5W	450lm	5700-6500K 2700-3200K	5x1W	60°	AC110 - 250V 50/60Hz	110 x 50	90
LD-7T LD-7V	7W	630lm	5700-6500K 2700-3200K	7x1W	60°	AC110 - 250V 50/60Hz	110 x 50	90
LD-9T LD-9V	9W	810lm	5700-6500K 2700-3200K	9x1W	60°	AC110 - 250V 50/60Hz	140 x 150	110
LD-12T LD-12V	12W	1080lm	5700-6500K 2700-3200K	12x1W	60°	AC110 - 250V 50/60Hz	140 x 150	110

LED Waterproof tube



Model	Power	Size		
		L	W	H
LWP-118T/ 118V	1 x 9W	662	86	85
LWP-218T/ 218V	2 x 9W	662	125	85
LWP-136T/ 136V	1 x 18W	1265	86	85
LWP-236T/ 236V	2 x 18W	1265	126	85

Ceiling Lamp Trough With Led Tube



Code	Power	Size		
		L	W	H
MATL-210T MATL-210V	2 x 10W	605	300	90
MATL-220T MATL-220V	2 x 20W	1215	300	90
MATL-310T MATL-310V	3 x 10W	605	600	90
MATL-320T MATL-320V	3 x 20W	1215	600	90

Code	power	Size (mm)		
		L	W	H
MWP 118	1x18W	660	86	90
MWP 136	1x36w	1270	86	90
MWP 218	2x18W	660	136	90
MWP 236	2x36W	1270	136	90



Slim Batten Lighting

MPE



Ballast



Electronic Ballsat



Starter



MBT 118/BL

MBT 116/BL

MBT 236/BL



Description	Code	Packing	L	H	H1	L1
Batten 1x36W	MBT 136	12 piece/carton	1190	24	60	45
Batten 2x36W	MBT 236	12 cây/carton	1190	24	60	45
Batten 1x18W	MBT 118	12 cây/carton	595	24	60	45
Batten 2x18W	MBT 218	12 cây/carton				
Ballsat 18W	BL - 18		170	23		37
Ballsat 36W	BL - 36		170	23		37
Stater	MS					

LED STRIP LIGHT

MPE



LSWW

LED Strip warm white
14,4w/met,12V DC
- Chip SMD 50x50
- 60 LED /1 meters
- Gummy, IP65

LSWH

LED Strip white light
14,4w/met,12V DC
- Chip SMD 50x50
- 60 LED /1 meters
- Gummy, IP65

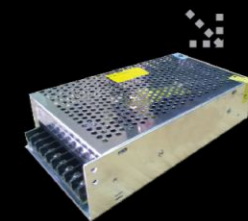

DLR-75W
Driver LED dây
Power: 75W
Voltage: 12VDC

Energy Saving Lamp 2U-3U-4U

MPE



Description	Code	Life
Lamp 2U - 5W White color	M2U5T	8000Hrs
Lamp 2U - 5W Warm white color	M2U5V	8000Hrs
Lamp 2U - 8W White color	M2U8T	8000Hrs
Lamp 2U - 8W Warm white color	M2U8V	8000Hrs
Lamp 3U - 11W White color	M3U11T	8000Hrs
Lamp 3U - 11W Warm white color	M3U11V	8000Hrs
Lamp 3U - 15W White color	M3U15T	8000Hrs
Lamp 3U - 15W Warm white color	M3U15V	8000Hrs
Lamp 3U - 18W White color	M3U18T	8000Hrs
Lamp 3U - 18W Warm white color	M3U18V	8000Hrs
Lamp 4U - 40W White color	M4U40T	8000Hrs
Lamp 4U - 55W Warm white color	M4U55T	8000Hrs

Lighting Fixture

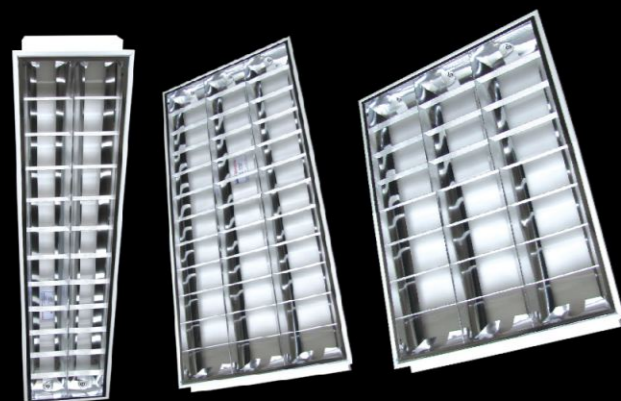

Code	Power	Size		
		L	W	H
MAT 218	2 x 18W	605	300	90
MAT 236	2 x 36W	1215	300	90
MAT 318	3 x 18W	605	600	90
MAT 336	3 x 36W	1215	600	90
MAT 418	4 x 18W	605	600	90

Full Spiral - Energy Saving Lamp

MPE



Code	Power	Color Temperature	Life
MX 9T	9W	5500-6000k	8000Hrs
MX 9V	9W	2700-3200k	8000Hrs

Safety Breaker



Dimension

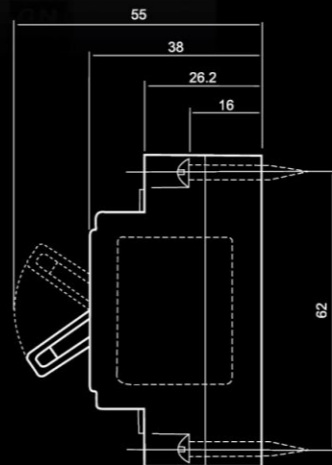
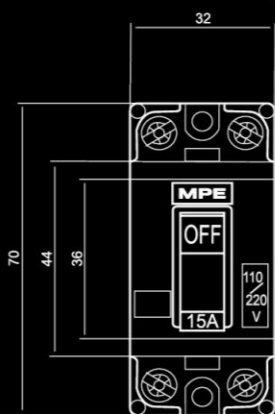
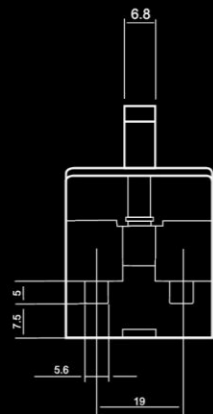

CAT. No.	Dimension
SB - 10	Safety breaker 10A
SB - 15	Safety breaker 15A
SB - 20	Safety breaker 20A
SB - 30	Safety breaker 30A

MCB - Miniature Circuit Breaker



MCB 1P



MCB 2P



MCB 3P



MCB 4P



Discription	Code	Packing
MCB 1P-10A-6KA	MP6-C110	12 PCS/box
MCB 1P-16A-6KA	MP6-C116	12 PCS/box
MCB 1P-20A-6KA	MP6-C120	12 PCS/box
MCB 1P-25A-6KA	MP6-C125	12 PCS/box
MCB 1P-32A-6KA	MP6-C132	12 PCS/box
MCB 1P-40A-6KA	MP6-C140	12 PCS/box
MCB 1P-50A-6KA	MP6-C150	12 PCS/box
MCB 1P-63A-6KA	MP6-C163	12 PCS/box

Discription	Code	Packing
MCB 2P-10A-6KA	MP6-C210	6 PCS/box
MCB 2P-16A-6KA	MP6-C216	6 PCS/box
MCB 2P-20A-6KA	MP6-C220	6 PCS/box
MCB 2P-25A-6KA	MP6-C225	6 PCS/box
MCB 2P-32A-6KA	MP6-C232	6 PCS/box
MCB 2P-40A-6KA	MP6-C240	6 PCS/box
MCB 2P-50A-6KA	MP6-C250	6 PCS/box
MCB 2P-63A-6KA	MP6-C263	6 PCS/box
MCB 2P-80A-10KA	MP10-C280	6 PCS/box
MCB 2P-100A-10KA	MP10-C2100	6 PCS/box

Discription	Code	Packing
MCB 3P-10A-6KA	MP6-C310	4 PCS/box
MCB 3P-16A-6KA	MP6-C316	4 PCS/box
MCB 3P-20A-6KA	MP6-C320	4 PCS/box
MCB 3P-25A-6KA	MP6-C325	4 PCS/box
MCB 3P-32A-6KA	MP6-C332	4 PCS/box
MCB 3P-40A-6KA	MP6-C340	4 PCS/box
MCB 3P-50A-6KA	MP6-C350	4 PCS/box
MCB 3P-63A-6KA	MP6-C363	4 PCS/box
MCB 3P-80A-10KA	MP10-C380	4 PCS/box
MCB 3P-100A-10KA	MP10-C3100	4 PCS/box

Discription	Code	Packing
MCB 4P -10A-6KA	MP6-C410	4 PCS/box
MCB 4P -16A-6KA	MP6-C416	4 PCS/box
MCB 4P -20A-6KA	MP6-C420	4 PCS/box
MCB 4P -25A-6KA	MP6-C425	4 PCS/box
MCB 4P -32A-6KA	MP6-C432	4 PCS/box
MCB 4P -40A-6KA	MP6-C440	4 PCS/box
MCB 4P -50A-6KA	MP6-C450	4 PCS/box
MCB 4P -63A-6KA	MP6-C463	4 PCS/box

Residual Current Circuit Breaker



ELCB 3P



Discription	Code	Packing
ELCB 2P-25A-30mA	MEL 30/225	6 PCS/box
ELCB 2P-40A-30mA	MEL 30/240	6 PCS/box
ELCB 2P-63A-30mA	MEL 30/263	6 PCS/box
ELCB 2P-25A-100mA	MEL 100/225	6 PCS/box
ELCB 2P-40A-100mA	MEL 100/240	6 PCS/box
ELCB 2P-63A-100mA	MEL 100/263	6 PCS/box

ELCB 4P



Discription	Code	Packing
ELCB 4P-25A-30mA	MEL 30/425	3 PCS/box
ELCB 4P-40A-30mA	MEL 30/440	3 PCS/box
ELCB 4P-63A-30mA	MEL 30/463	3 PCS/box
ELCB 4P-25A-100mA	MEL 100/425	3 PCS/box
ELCB 4P-40A-100mA	MEL 100/440	3 PCS/box
ELCB 4P-63A-100mA	MEL 100/463	3 PCS/box

Residual Circuit Breaker Overcurrent



Discription	Code	Packing
RCBO 2P-25A-30mA-6KA	RCBO-30/225	6 PCS/box
RCBO 2P-32A-30mA-6KA	RCBO-30/232	6 PCS/box
RCBO 2P-40A-30mA-6KA	RCBO-30/240	6 PCS/box
RCBO 2P-63A-30mA-6KA	RCBO-30/263	6 PCS/box

Achievements



- The top brand in 2005
- Prize Vietnam high quality goods 2006
- Certified quality management system ISO 9001-2008
- Achieved gold and gold medal construction industry exhibition 2006 ,2007, 2008, 2009, 2010
- Gain prestige badge & quality 2007
- Brand gold award Vietnam 2007
- Certified General Department of Taxation 2006
- Certified of Ministry of Finance 2007
- Pople's Committee of HCM city 2008
- Certified HCMC Department of Culture and Sports 2007,2008,2009



Team MPE



Ceremony conclusion of cooperation strategy 2015



MPE league Cup 2012



MPE Leaders



MPE Exhibition



MPE league Cup 2014

Building Trust And Use MPE:

- HAGL compound – Dist 7 – HCMC
- 4S apartment – Dist Thu Duc – HCMC
- Estella apartment – Dist 2- HCMC
- Phu My Thuan Apartment – Nha Be – HCMC
- Intel factory Vietnam – Dist 9 – HCMC
- HMTc apartment – Dist 1- HCMC
- Vung Tau convention center
- HADECO apartment – Vung Tau city
- Aquaba Resort - Phan Thiet city
- Dong Nai 2 - hydropower plants – Lam Dong
- Thuy Tu apartment – Da Nang City
- VINMEC international hospital - Ha Noi
- Mandarin apartment - Ha Noi
- Victoria luxury apartment - Ha Noi
- Dai dia bao residence - Da Nang City
- Shanghai Resort - Cambodia